



YOUR OUTDOOR LIVING

contract
collection
2016

feeling better

FUNCTIONAL, long-lasting, high-quality designer furnishings.

A wide selection that is Made in Italy and

designed for **professional** outdoor spaces.

Design, qualité, fonctionnalité et **durabilité**.

Une VASTE GAMME de meubles Made in Italy
conçus pour l'extérieur professionnel.

Design, **Qualität**, Funktionalität und Haltbarkeit.

Ein reichhaltiges Angebot an Einrichtungsgegenständen
MADE IN ITALY für den professionellen Outdoor-Bereich.

Diseño, calidad, **funcionalidad** y durabilidad.

Una amplia gama de mobiliario Made in Italy

PENSADOS PARA EL AIRE libre profesional.

DESIGN, qualidade, funcionalidade e durabilidade.

Uma ampla gama de decorações Made in Italy
estudadas para o **Outdoor** profissional.

Tasarım, **Kalite** ve Sağlık.

Geniş bir yelpazeye sahip İtalyan üretimi

mobilyalar, özellikle PROFESYONEL dış

mekan kullanımı için tasarlanmıştır.

ДИЗАЙН, КАЧЕСТВО и ДЛИТЕЛЬНОЕ ИСПОЛЬЗОВАНИЕ.

ШИРОКАЯ ГАММА МЕБЕЛИ НАРДИ MADE IN ITALY ДЛЯ
ПРОФЕССИОНАЛЬНОГО ИСПОЛЬЗОВАНИЯ НА ОТКРЫТОМ ВОЗДУХЕ.

contract collection 2016

design by
Raffaello Galotto

Nardi #FeelingBetter

Design, **QUALITÀ**, funzionalità e durabilità.

Un'ampia gamma di arredi Made in Italy
pensati per l'**outdoor** professionale.



net

net

fiore



net



faro



lido



lido

bora

bora bistrot



riva



faro



riva bistrot





costa bistrot



costa



fiore



ibisco





spritz

step





loto relax 95

ninfea relax

ninfea dinner

aria poltrona



aria tavolino 60



aria tavolino 100



aria poltrona

fiore



aria poltrona



palma

cube

erica

calice



calice high



scudo high



scudo double



scudo

duca



conte



principe



regina



dama





artica wicker

artica



aurora

alaska

globo

darsena



acquamarina



atlantico



alfa



omega





eden

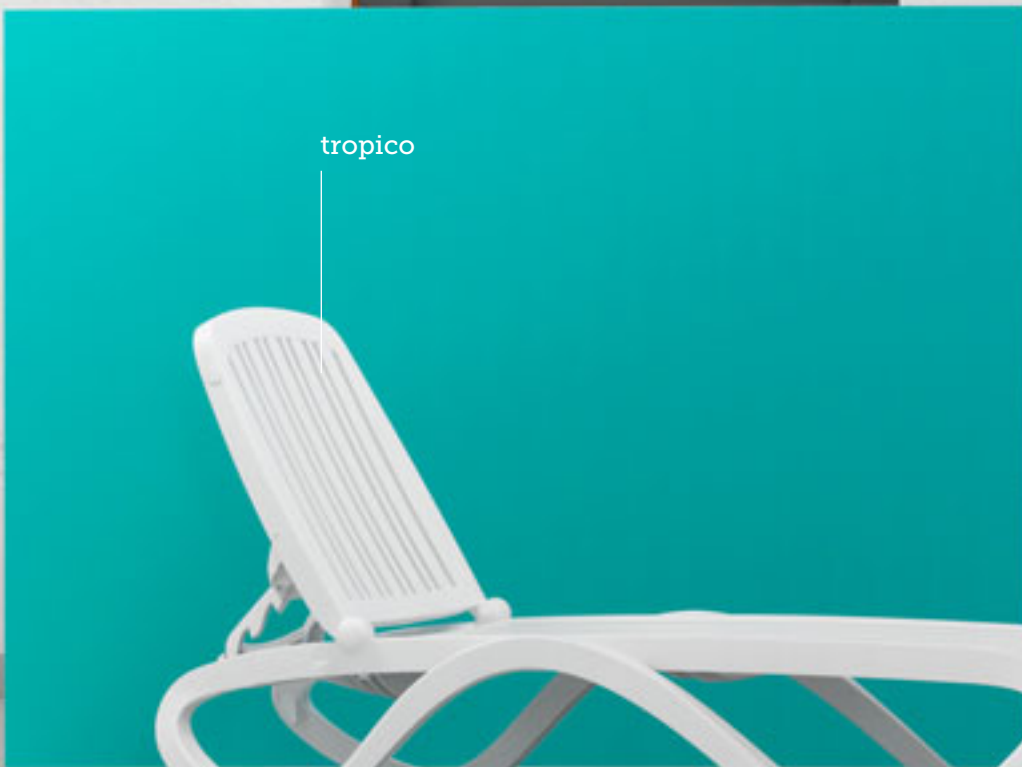

tropico



Italy



Malta



Italy

Nardi...
nel mondo
in the world
en el mundo
dans le monde
in der Welt
no mundo
Dünya çarında
в мире



Spain



Cyprus

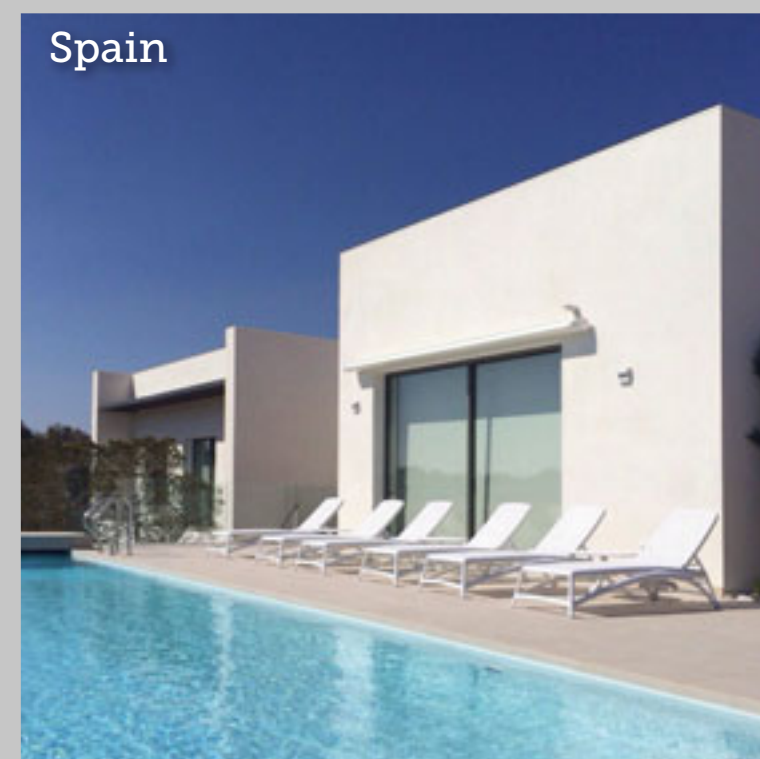

Spain



Croatia



Bulgaria



Greece



Italy



Greece

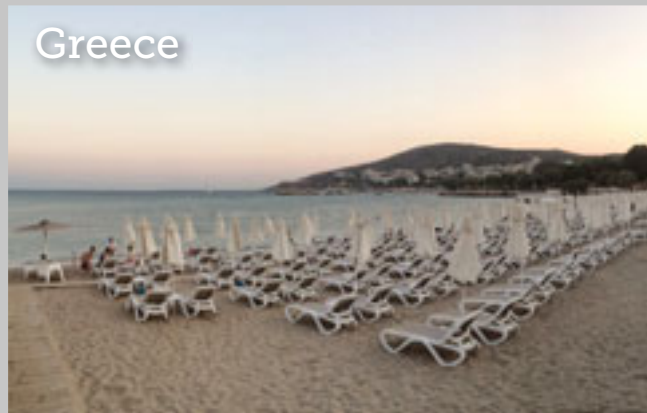

Malta



Turkey



Turkey



Malaysia



Mauritius



Cyprus



Israel



Brazil



Panama



Romania



Romania

net new

polipropilene fiberglass

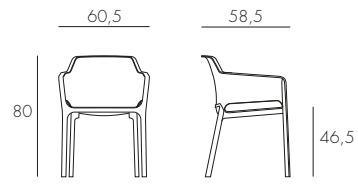

4 kg
n. pz. 22



BIANCO 40326.00.000
ANTRACITE 40326.02.000
TORTORA 40326.10.000
SENAPE 40326.56.000
CORALLO 40326.75.000

ninfea dinner

polipropilene alluminio

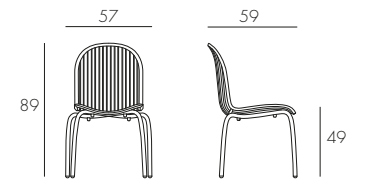

4,6 kg
n. pz. 6



BIANCO anodizzato 62050.00.000
ANTRACITE anodizzato 62050.02.000
CAFFÈ anodizzato 62050.05.000
BIANCO vernic. bianco 62053.00.000

palma

polipropilene

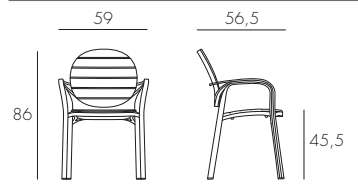

5,4 kg
n. pz. 6



BIANCO 40237.00.000
BIANCO TORTORA 40237.00.010
BIANCO AVANA 40237.00.033
ANTRACITE 40237.02.002
CAFFÈ 40237.05.005
TORTORA 40237.10.010

ninfea relax

polipropilene alluminio

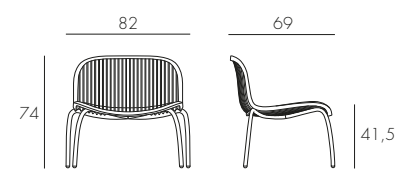

7,2 kg
n. pz. 2



BIANCO anodizzato 62250.00.000
ANTRACITE anodizzato 62250.02.000
CAFFÈ anodizzato 62250.05.000
BIANCO vernic. bianco 62253.00.000

erica

polipropilene

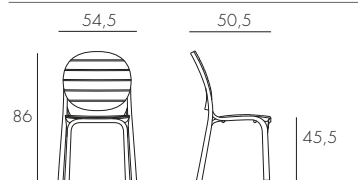

4,2 kg
n. pz. 22



BIANCO 40236.00.000
BIANCO TORTORA 40236.00.010
BIANCO AVANA 40236.00.033
ANTRACITE 40236.02.002
CAFFÈ 40236.05.005
TORTORA 40236.10.010

acquamarina

polipropilene fiberglass

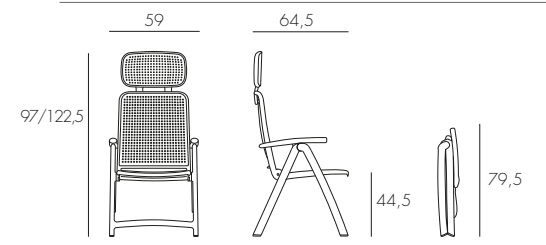

8,2 kg
n. pz. 1



BIANCO 40314.00.000
ANTRACITE 40314.02.000
CAFFÈ 40314.05.000
TORTORA 40314.10.000
CELESTE 40314.39.000

darsena new

polipropilene fiberglass

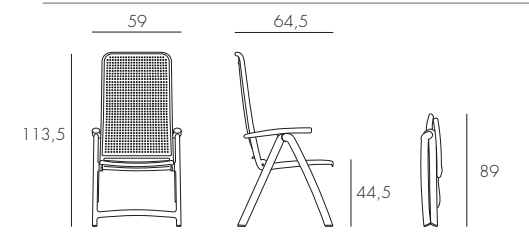

7,7 kg
n. pz. 1



BIANCO 40316.00.000
ANTRACITE 40316.02.000
CAFFÈ 40316.05.000
TORTORA 40316.10.000
CELESTE 40316.39.000

bora

polipropilene fiberglass

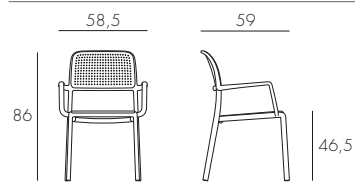

4,4 kg
n. pz. 24



BIANCO
40242.00.000



ANTRACITE
40242.02.000



CAFFÈ
40242.05.000



ROSSO
40242.07.000



TORTORA
40242.10.000



AVANA
40242.33.000



CELESTE
40242.39.000

riva bistrot

polipropilene fiberglass

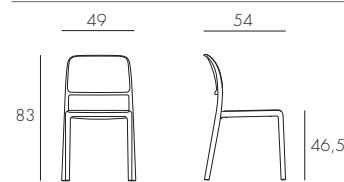

3,9 kg
n. pz. 24



BIANCO
40247.00.000



ANTRACITE
40247.02.000



CAFFÈ
40247.05.000



ROSSO
40247.07.000



TORTORA
40247.10.000



LIME
40247.12.000



ARANCIO
40247.26.000



AVANA
40247.33.000



CELESTE
40247.39.000

bora bistrot

polipropilene fiberglass

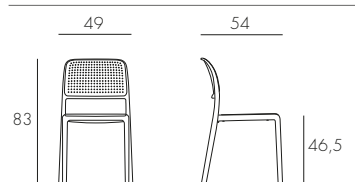

3,7 kg
n. pz. 24



BIANCO
40243.00.000



ANTRACITE
40243.02.000



CAFFÈ
40243.05.000



ROSSO
40243.07.000



TORTORA
40243.10.000



LIME
40243.12.000



PURPLE
40243.13.000



ARANCIO
40243.26.000



AVANA
40243.33.000



CELESTE
40243.39.000

costa

polipropilene fiberglass

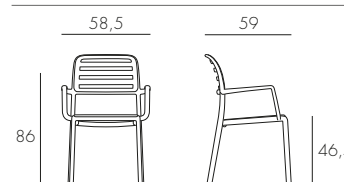

4,5 kg
n. pz. 24



BIANCO
40244.00.000



ANTRACITE
40244.02.000



CAFFÈ
40244.05.000



ROSSO
40244.07.000



TORTORA
40244.10.000



CELESTE
40244.39.000

costa bistrot

polipropilene fiberglass

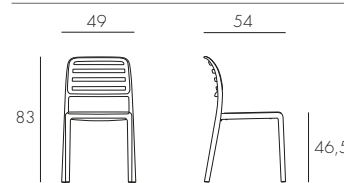

3,8 kg
n. pz. 24



BIANCO
40245.00.000



ANTRACITE
40245.02.000



CAFFÈ
40245.05.000



ROSSO
40245.07.000



TORTORA
40245.10.000



LIME
40245.12.000



ARANCIO
40245.26.000



CELESTE
40245.39.000

riva

polipropilene fiberglass

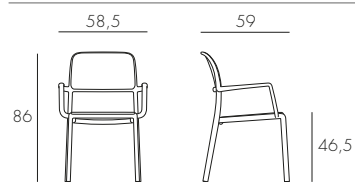

4,6 kg
n. pz. 24



BIANCO
40246.00.000



ANTRACITE
40246.02.000



CAFFÈ
40246.05.000



ROSSO
40246.07.000



TORTORA
40246.10.000



CELESTE
40246.39.000

aria

polipropilene
tessuto acrilico •

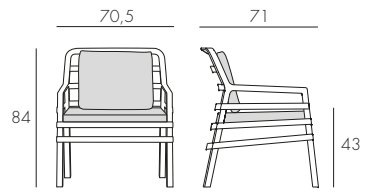

7,9 kg
n. pz. 1

BIANCO lime 40330.00.061.061	BIANCO cherry 40330.00.065.065	BIANCO melanzana 40330.00.068.068	BIANCO bianco 40330.00.155.155	BIANCO grigio 40330.00.163.163	BIANCO caffè 40330.00.165.165	BIANCO arancio 40330.00.166.166
ANTRACITE lime 40330.02.061.061	ANTRACITE cherry 40330.02.065.065	ANTRACITE melanzana 40330.02.068.068	ANTRACITE bianco 40330.02.155.155	ANTRACITE grigio 40330.02.163.163	ANTRACITE caffè 40330.02.165.165	ANTRACITE arancio 40330.02.166.166
CAFFÈ lime 40330.05.061.061	CAFFÈ cherry 40330.05.065.065	CAFFÈ melanzana 40330.05.068.068	CAFFÈ bianco 40330.05.155.155	CAFFÈ grigio 40330.05.163.163	CAFFÈ caffè 40330.05.165.165	CAFFÈ arancio 40330.05.166.166
ROSSO lime 40330.07.061.061	ROSSO cherry 40330.07.065.065	ROSSO melanzana 40330.07.068.068	ROSSO bianco 40330.07.155.155	ROSSO grigio 40330.07.163.163	ROSSO caffè 40330.07.165.165	ROSSO arancio 40330.07.166.166
TORTORA lime 40330.10.061.061	TORTORA cherry 40330.10.065.065	TORTORA melanzana 40330.10.068.068	TORTORA bianco 40330.10.155.155	TORTORA grigio 40330.10.163.163	TORTORA caffè 40330.10.165.165	TORTORA arancio 40330.10.166.166
AVANA lime 40330.33.061.061	AVANA cherry 40330.33.065.065	AVANA melanzana 40330.33.068.068	AVANA bianco 40330.33.155.155	AVANA grigio 40330.33.163.163	AVANA caffè 40330.33.165.165	AVANA arancio 40330.33.166.166

* Disponibile a magazzino - Available ex-stock - Disponible sur stock - Ab Lager verfügbar - Disponible en almacén habitualmente - Disponivel em estoque - Stokta mevcut - Наличие на складе

* Disponibile su ordine - Available to order - Disponible sur commande - Mit Auftrag verfügbar - Disponible sólo sobre pedido - Disponivel sob encomenda - Sipariş göre hazırlanacaktır - Под заказ

• melanzana - bianco - caffè - arancio = acrilico 190 gr/m²
lime - cherry - grigio = acrilico 240 gr/m²

musa

polipropilene
alluminio

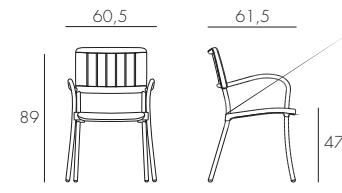

4,2 kg
n. pz. 24



BIANCO anodizzato argento 61050.00.000	CAFFÈ anodizzato argento 61050.05.000	TORTORA anodizzato argento 61050.10.000	ANTRACITE verniciato antracite 61052.02.000	TORTORA verniciato tortora 61059.10.000
--	---	---	---	---

zac classic

polipropilene fiberglass

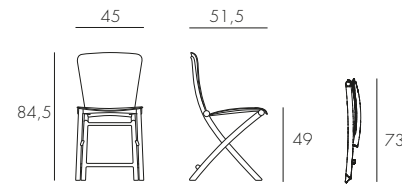

3,9 kg
n. pz. 1



BIANCO 40324.00.000	GRIGIO 40324.03.000	LIME 40324.12.000	PURPLE 40324.13.000	ARANCIO 40324.26.000
------------------------	------------------------	----------------------	------------------------	-------------------------

zac spring

polipropilene fiberglass

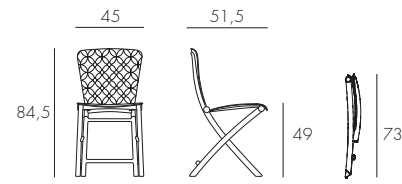

3,9 kg
n. pz. 1



BIANCO 40325.00.000	ANTRACITE 40325.02.000	ROSSO 40325.07.000	LIME 40325.12.000	PURPLE 40325.13.000	ARANCIO 40325.26.000
------------------------	---------------------------	-----------------------	----------------------	------------------------	-------------------------

dama

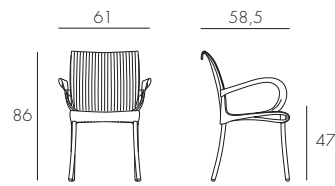

3,8 kg
n. pz. 18



ANTRACITE
anodizzato argento
61650.02.000

CAFFÈ
anodizzato argento
61650.05.000

ROSSO
anodizzato argento
61650.07.000

TORTORA
anodizzato argento
61650.10.000

MUSCHIO
anodizzato argento
61650.25.000

ARANCIO
anodizzato argento
61650.26.000



BURRO
anodizzato argento
61650.28.000

polipropilene
alluminio

artica

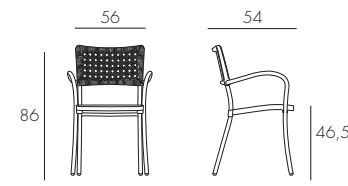

3,3 kg
n. pz. 24



PAGLIA
anodizzato argento
60050.29.000

ANTRACITE
verniciato antracite
60052.02.000

PAGLIA
verniciato antracite
60052.29.000

polipropilene
alluminio

regina

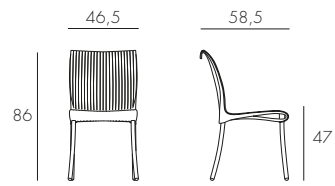

3,1 kg
n. pz. 18



ANTRACITE
anodizzato argento
61850.02.000

CAFFÈ
anodizzato argento
61850.05.000

ROSSO
anodizzato argento
61850.07.000

TORTORA
anodizzato argento
61850.10.000

MUSCHIO
anodizzato argento
61850.25.000

ARANCIO
anodizzato argento
61850.26.000



BURRO
anodizzato argento
61850.28.000

polipropilene
alluminio

artica wicker

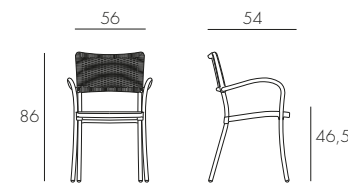

3,3 kg
n. pz. 24



ANTRACITE
anodizzato argento
60150.02.000

CAFFÈ
anodizzato argento
60150.05.000

ANTRACITE
verniciato antracite
60152.02.000

polipropilene
alluminio

aurora

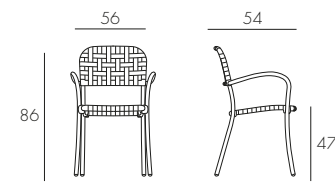

3,3 kg
n. pz. 24



BIANCO
anodizzato argento
60250.00.000

ANTRACITE
anodizzato argento
60250.02.000

CAFFÈ
anodizzato argento
60250.05.000

MUSCHIO
anodizzato argento
60250.25.000

ARANCIO
anodizzato argento
60250.26.000

ANTRACITE
verniciato antracite
60252.02.000

polipropilene
alluminio

alaska

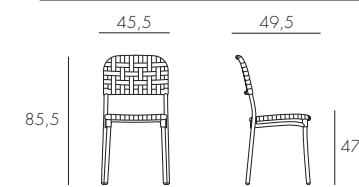

2,9 kg
n. pz. 18



BIANCO
anodizzato argento
60450.00.000

ANTRACITE
anodizzato argento
60450.02.000

CAFFÈ
anodizzato argento
60450.05.000

MUSCHIO
anodizzato argento
60450.25.000

ARANCIO
anodizzato argento
60450.26.000

ANTRACITE
verniciato antracite
60452.02.000

polipropilene
alluminio

regina indoor

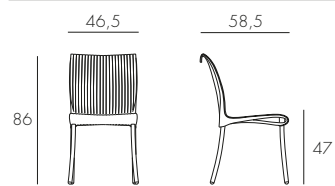

3,5 kg
n. pz. 18



ANTRACITE
61880.02.000

ROSSO
61880.07.000

BURRO
61880.28.000

polipropilene
acciaio cromato

lido new

polipropilene fiberglass

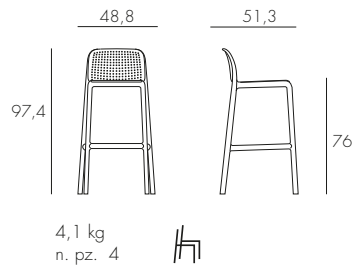

4,1 kg
n. pz. 4



BIANCO 40344.00.000 ANTRACITE 40344.02.000 CAFFÈ 40344.05.000 ROSSO 40344.07.000 TORTORA 40344.10.000 AVANA 40344.33.000



CELESTE 40344.39.000

duca

polipropilene alluminio

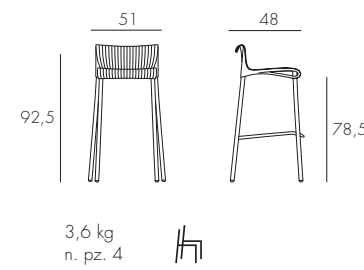

3,6 kg
n. pz. 4



ANTRACITE verniciato argento 75254.02.000 CAFFÈ verniciato argento 75254.05.000 ROSSO verniciato argento 75254.07.000 TORTORA verniciato argento 75254.10.000 MUSCHIO verniciato argento 75254.25.000 ARANCIO verniciato argento 75254.26.000



BURRO verniciato argento 75254.28.000

faro new

polipropilene fiberglass

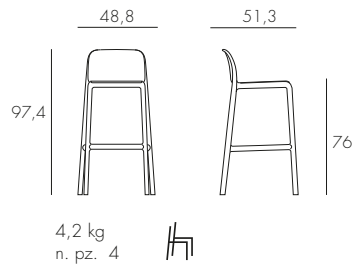

4,2 kg
n. pz. 4



BIANCO 40346.00.000 ANTRACITE 40346.02.000 CAFFÈ 40346.05.000 ROSSO 40346.07.000 TORTORA 40346.10.000 CELESTE 40346.39.000

conte indoor

polipropilene acciaio cromato

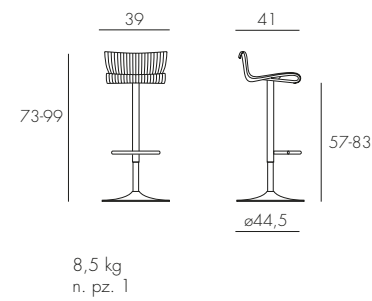

8,5 kg
n. pz. 1



ANTRACITE 75080.02.000 ROSSO 75080.07.000 BURRO 75080.28.000

globo

polipropilene alluminio

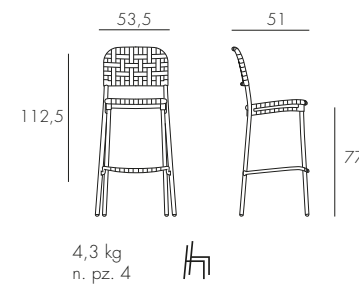

4,3 kg
n. pz. 4



BIANCO verniciato argento 75454.00.000 ANTRACITE verniciato argento 75454.02.000 CAFFÈ verniciato argento 75454.05.000 MUSCHIO verniciato argento 75454.25.000 ARANCIO verniciato argento 75454.26.000 ANTRACITE verniciato antracite 75452.02.000

atlantico

polipropilene fiberglass
tessuto sintetico 1x1

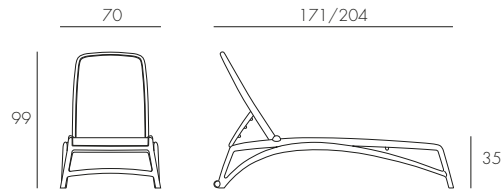

16 kg
n. pz. 20

Tessuto ricambiabile
Replaceable fabric
Tissu changeable
Auswechselbarer Stoff
Tela sustituibile
Tecidos recambiáveis
Değiştirilebilen Kumaş
Съемная ткань



alfa

polipropilene
tessuto sintetico

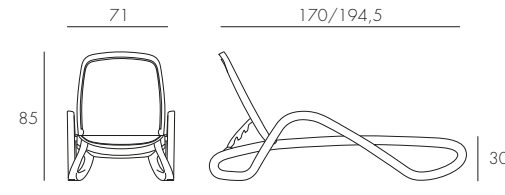

13,3 kg
n. pz. 17

Tessuto ricambiabile
Replaceable fabric
Tissu changeable
Auswechselbarer Stoff
Tela sustituibile
Tecidos recambiáveis
Değiştirilebilen Kumaş
Съемная ткань



bracciolo atlantico **new**

polipropilene fiberglass

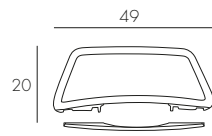

1,1 kg
n. pz. 1

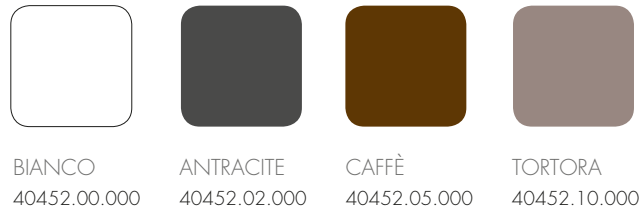

ricambio atlantico

polipropilene
tessuto sintetico 1x1

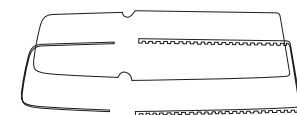

1,3 kg
n. pz. 1

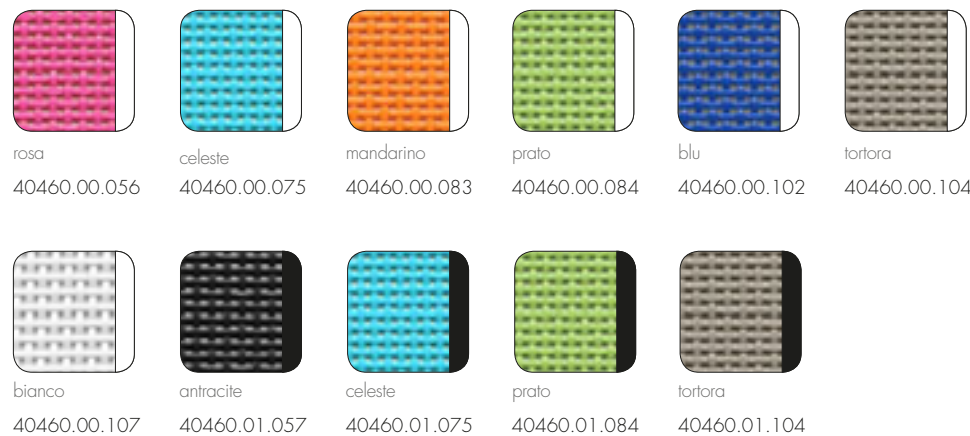

omega

polipropilene
tessuto sintetico

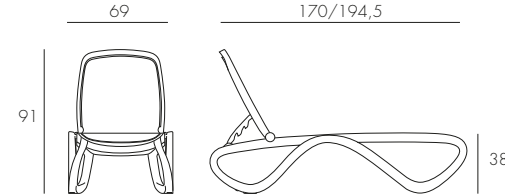

14,3 kg
n. pz. 18

Tessuto ricambiabile
Replaceable fabric
Tissu changeable
Auswechselbarer Stoff
Tela sustituibile
Tecidos recambiáveis
Değiştirilebilen Kumaş
Съемная ткань



parasole

alfa omega eden tropico

polipropilene
tessuto sintetico

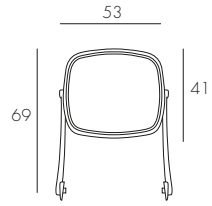

1,4 kg
n. pz. 1



eden

polipropilene

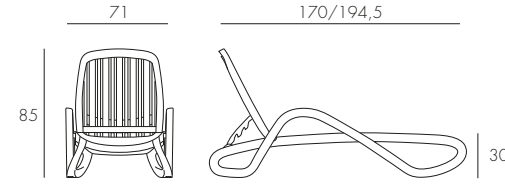

14,7 kg
n. pz. 17

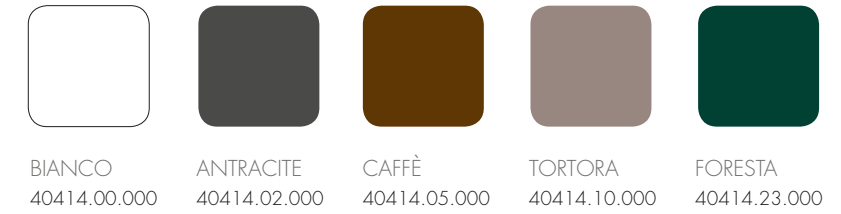

tropico

polipropilene

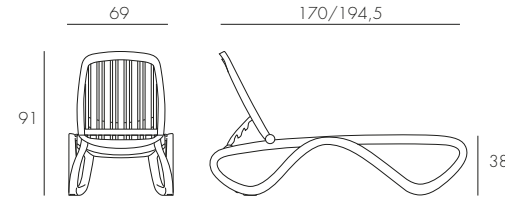

14,5 kg
n. pz. 18

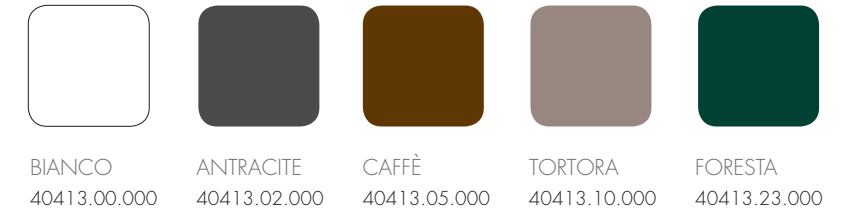

ricambio alfa omega

polipropilene
tessuto sintetico

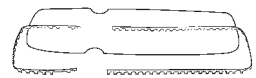

1,8 kg
n. pz. 1

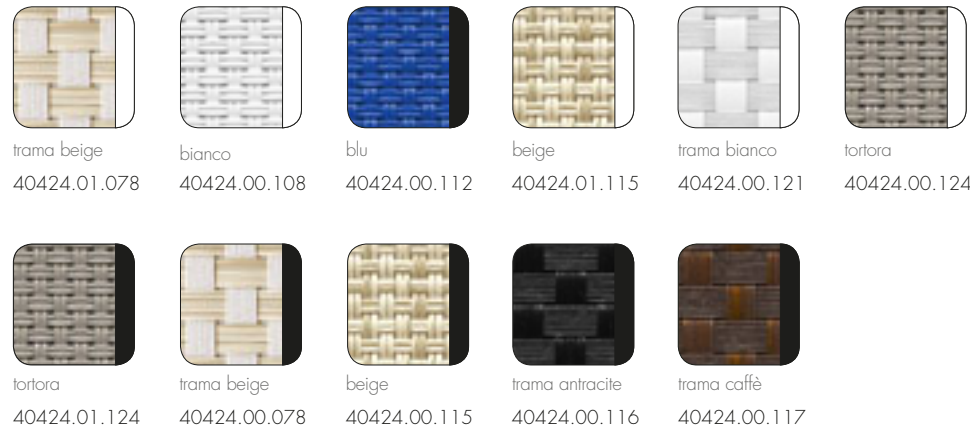

loto relax 95

vetro
alluminio

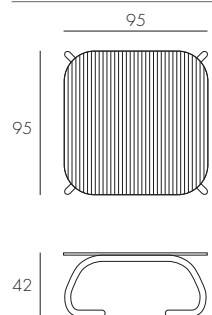

27 kg
n. pz. 1



BIANCO
anodizzato
44750.00.000

ANTRACITE
anodizzato
44750.02.000

CAFFÈ
anodizzato
44750.05.000

BIANCO
verniciato bianco
44753.00.000

loto relax 60

laminato
alluminio

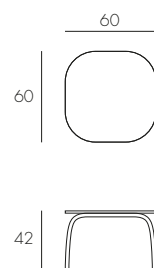

7 kg
n. pz. 1



BIANCO
anodizzato
44650.00.301

ANTRACITE
anodizzato
44650.00.303

CAFFÈ
anodizzato
44650.00.302

BIANCO
verniciato bianco
44653.00.301

aria tavolino 60

polipropilene

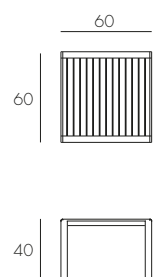

5 kg
n. pz. 1



BIANCO
40051.00.000

ANTRACITE
40051.02.000

CAFFÈ
40051.05.000

ROSSO
40051.07.000

TORTORA
40051.10.000

AVANA
40051.33.000

aria tavolino 100

polipropilene

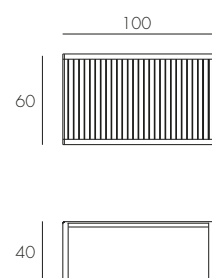

6,9 kg
n. pz. 1



BIANCO
40052.00.000

ANTRACITE
40052.02.000

CAFFÈ
40052.05.000

ROSSO
40052.07.000

TORTORA
40052.10.000

AVANA
40052.33.000

cube new

polipropilene
alluminio

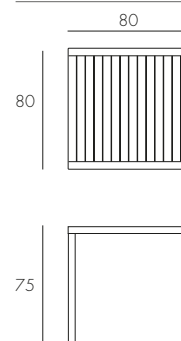

n. pz. 1



ANTRACITE
verniciato antracite
48052.02.000

BIANCO
verniciato bianco
48053.00.000

CAFFÈ
verniciato caffè
48057.05.000

TORTORA
verniciato tortora
48059.10.000

maestrale 90

DurelTOP - polipropilene
alluminio

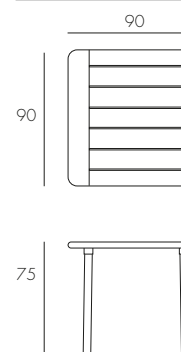

13,5 kg
n. pz. 1



BIANCO
anodizzato argento
42050.00.000

ANTRACITE
anodizzato argento
42050.02.000

CAFFÈ
anodizzato argento
42050.05.000

TORTORA
anodizzato argento
42050.10.000

ANTRACITE
verniciato antracite
42052.02.000

step

polipropilene fiberglass

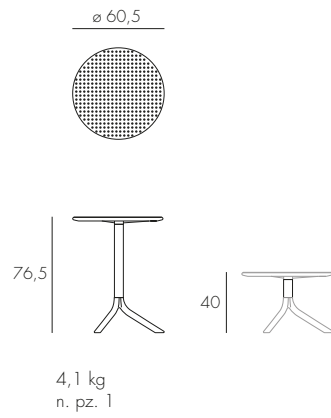

spritz

polipropilene fiberglass

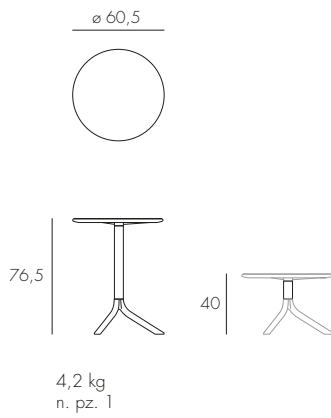

base ibisco

piani ø60 - ø70 - ø80 - 60x60 - 70x70 - 80x80

alluminio

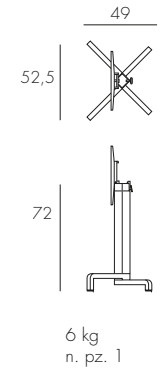

base ibisco high

piani ø60 - ø70 - 60x60 - 70x70

alluminio

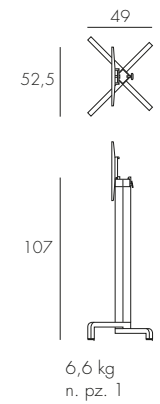

base fiore

piani ø60 - ø70 - ø80 - 60x60 - 70x70 - 80x80

alluminio

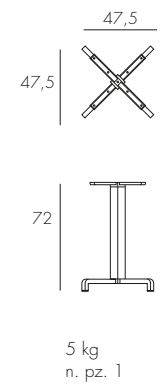

base fiore high

per piani ø60 - ø70 - 60x60 - 70x70

alluminio

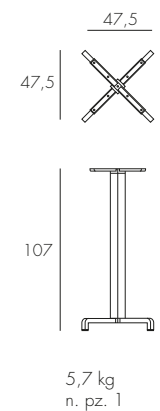

base scudo

piani ø60 - ø70 - ø80 - 60x60 -70x70 - 80x80

alluminio

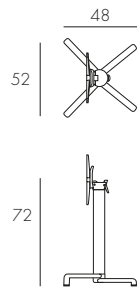

5,8 kg
n. pz. 1



base scudo high

piani ø60 - ø70 - 60x60 -70x70

alluminio

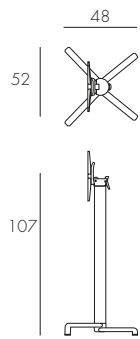

6,5 kg
n. pz. 1



base scudo double

piani 110x170 -120x80

alluminio

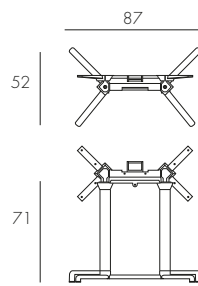

8,7 kg
n. pz. 1



base flute

piani ø60 - ø70

alluminio

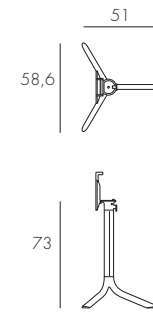

4,8 kg
n. pz. 1



base break **new**

piani ø60 - ø70

alluminio

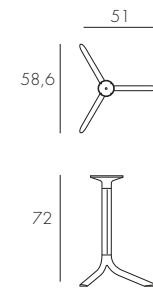

4,3 kg
n. pz. 1

base calice ALU

piani ø60 - ø70 - ø80 - 60x60 -70x70 - 80x80

alluminio

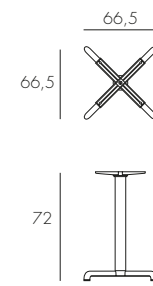

4,4 kg
n. pz. 1

base calice ALU high

piani ø60 - ø70 - 60x60 -70x70

alluminio

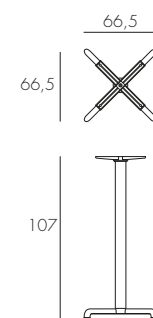

5,5 kg
n. pz. 1

■ trattamento speciale per ambienti ad alto tasso salino - special treatment for high salinity environments - traitement spécial pour les environnements a haute salinité - Sonderbehandlung für Ambiente mit hohem Salzgehalt - tratamiento especial para ambientes con alta salinidad - yüksek tuza maruz kalan alanlar için özel bakım - Специальная обработка для среды с высоким содержанием соли

■ trattamento speciale per ambienti ad alto tasso salino - special treatment for high salinity environments - traitement spécial pour les environnements a haute salinité - Sonderbehandlung für Ambiente mit hohem Salzgehalt - tratamiento especial para ambientes con alta salinidad - yüksek tuza maruz kalan alanlar için özel bakım - Специальная обработка для среды с высоким содержанием соли

base principe 42 indoor piani ø60 - ø70 - 60x60

acciaio cromato



base principe 45 indoor piani ø60 - ø70 - ø80 - 60x60 - 70x70 - 80x80

inox alluminio



base principe 40x40 indoor piani ø60 - ø70 - ø80 - 60x60 - 70x70 - 80x80

inox alluminio



piani laminato base calice - principe - scudo - scudo double - ibisco - fiore - flute - break

			GRIGIO	BIANCO	CAFFÈ	ANTRACITE	CEMENTO	TORTORA
		1,2 cm						
piano Ø60		4,5 kg n. pz. 2	30616.10.300	30616.10.301	30616.10.302	30616.10.303	30616.10.305	30616.10.310
piano Ø70		6,2 kg n. pz. 2	30617.10.300	30617.10.301	30617.10.302	30617.10.303	30617.10.305	30617.10.310
piano Ø80		8,1 kg n. pz. 2	30618.10.300	30618.10.301	30618.10.302	30618.10.303	30618.10.305	30618.10.310
piano 60x60		5,8 kg n. pz. 2	30606.10.300	30606.10.301	30606.10.302	30606.10.303	30606.10.305	30606.10.310
piano 70x70		7,9 kg n. pz. 2	30607.10.300	30607.10.301	30607.10.302	30607.10.303	30607.10.305	30607.10.310
piano 80x80		10,9 kg n. pz. 2	30608.10.300	30608.10.301	30608.10.302	30608.10.303	30608.10.305	30608.10.310
piano 110x70		12,4 kg n. pz. 2	30621.10.300	30621.10.301				
piano 120x80		15,5 kg n. pz. 2	30620.10.300	30620.10.301				

piani werzalit base calice - principe - scudo - scudo double - ibisco - fiore - flute - break

			GRANITO *	BIANCO	CATALAN	ARGENTO	WICKER *
piano Ø60		sp. 2,6 cm 4,3 kg n. pz. 1	30016.10.189	30016.10.190	30016.10.194	30016.10.197	30016.10.198
piano Ø70		sp. 2,6 cm 5,5 kg n. pz. 1	30017.10.189	30017.10.190	30017.10.194	30017.10.197	30017.10.198
piano Ø80		sp. 2,6 cm 6,7 kg n. pz. 1	30018.10.189	30018.10.190	30018.10.194	30018.10.197	30018.10.198
piano 60x60		sp. 3 cm 5 kg n. pz. 1	30006.10.189	30006.10.190	30006.10.194	30006.10.197	30006.10.198
piano 70x70		sp. 3 cm 7 kg n. pz. 1	30007.10.189	30007.10.190	30007.10.194	30007.10.197	30007.10.198
piano 80x80		sp. 3,3 cm 9,4 kg n. pz. 1	30008.10.189	30008.10.190	30008.10.194	30008.10.197	30008.10.198
piano 110x70		sp. 3 cm 11,4 kg n. pz. 1		30021.10.190	30021.10.194	30021.10.197	
piano 120x80		sp. 3,3 cm 14,7 kg n. pz. 1		30020.10.190	30020.10.194	30020.10.197	

* Posizionare in zona d'ombra - Only use table tops in shaded areas - Plateaux qui doivent être utilisés uniquement dans des zones ombragées - Tischplatten nur für beschatteten Einsatzbereich - Utilizar estos tableros sólo en áreas sombreadas - Gölge alana koyun - Ставить в тени

polo werzalit

WERZALIT BIANCO bianco anodizzato	WERZALIT ARGENTO antracite anodizzato	WERZALIT ARGENTO grigio anodizzato	WERZALIT ARGENTO caffè anodizzato	WERZALIT CATALAN crema anodizzato	WERZALIT ARGENTO rosso grigio anodizzato	WERZALIT * GRANITO antracite vern. antracite	WERZALIT CATALAN crema vern. antracite
							

polo ø60

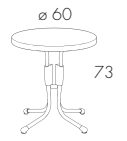

8,6 kg
n. pz. 1

51650.00.190	51650.02.197	51650.03.197	51650.05.197	51650.06.194	51650.07.197		51652.06.194
--------------	--------------	--------------	--------------	--------------	--------------	--	--------------

polo ø70

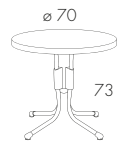

9 kg
n. pz. 1

51750.00.190	51750.02.197	51750.03.197	51750.05.197	51750.06.194	51750.07.197	51752.02.189	51752.06.194
--------------	--------------	--------------	--------------	--------------	--------------	--------------	--------------

polo ø80

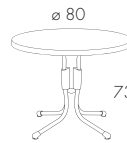

11,1 kg
n. pz. 1

51850.00.190	51850.02.197	51850.03.197	51850.05.197	51850.06.194	51850.07.197	51852.02.189	51852.06.194
--------------	--------------	--------------	--------------	--------------	--------------	--------------	--------------

polo 60x60

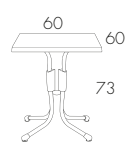

8,6 kg
n. pz. 1

50650.00.190	50650.02.197	50650.03.197	50650.05.197	50650.06.194	50650.07.197	50652.02.189	50652.06.194
--------------	--------------	--------------	--------------	--------------	--------------	--------------	--------------

polo 70x70

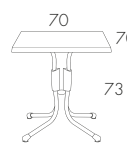

10,2 kg
n. pz. 1

50750.00.190	50750.02.197	50750.03.197	50750.05.197	50750.06.194	50750.07.197	50752.02.189	50752.06.194
--------------	--------------	--------------	--------------	--------------	--------------	--------------	--------------

polo 80x80

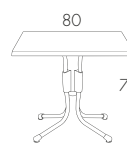

12,7 kg
n. pz. 1

50850.00.190	50850.02.197	50850.03.197	50850.05.197	50850.06.194	50850.07.197	50852.02.189	50852.06.194
--------------	--------------	--------------	--------------	--------------	--------------	--------------	--------------

polo 110x70

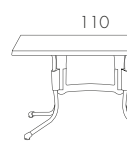

16,7 kg
n. pz. 1

51150.00.190	51150.02.197	51150.03.197	51150.05.197	51150.06.194	51150.07.197		51152.06.194
--------------	--------------	--------------	--------------	--------------	--------------	--	--------------

polo 120x80

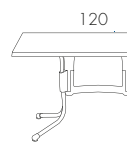

20,1 kg
n. pz. 1

51250.00.190	51250.02.197	51250.03.197	51250.05.197	51250.06.194	51250.07.197		51252.06.194
--------------	--------------	--------------	--------------	--------------	--------------	--	--------------

polo DurelTOP 70x70

DurelTOP - polipropilene
alluminio

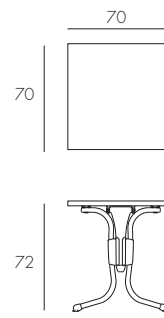

7,9 kg
n. pz. 1

					
DurelTOP BIANCO BIANCO anodizzato argento 50750.00.400	DurelTOP GRIGIO ANTRACITE anodizzato argento 50750.02.403	DurelTOP GRIGIO GRIGIO anodizzato argento 50750.03.403	DurelTOP GRIGIO CAFFÈ anodizzato argento 50750.05.403	DurelTOP GRIGIO ROSSO anodizzato argento 50750.07.403	DurelTOP ANTRACITE * ANTRACITE verniciato antracite 50752.02.402

polo DurelTOP 80x80

DurelTOP - polipropilene
alluminio

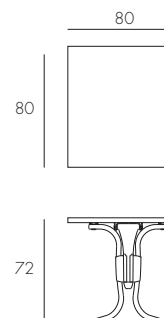

11,4 kg
n. pz. 1



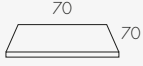
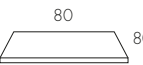

					
DurelTOP BIANCO BIANCO anodizzato argento 50850.00.400	DurelTOP GRIGIO ANTRACITE anodizzato argento 50850.02.403	DurelTOP GRIGIO GRIGIO anodizzato argento 50850.03.403	DurelTOP GRIGIO CAFFÈ anodizzato argento 50850.05.403	DurelTOP GRIGIO ROSSO anodizzato argento 50850.07.403	DurelTOP ANTRACITE * ANTRACITE verniciato antracite 50852.02.402

* Posizionare in zona d'ombra - Only use table tops in shaded areas - Plateaux qui doivent être utilisés uniquement dans des zones ombragées - Tischplatten nur für beschatteten Einsatzbereich - Utilizar estos tableros sólo en áreas sombreadas - Gölge alana koyun - Ставить в тени

piani DurelTOP base calice - iceberg 80x80 - scudo - ibisco - fiore



		BIANCO	ANTRACITE *	GRIGIO	CAFFÈ *	TORTORA
piano 70x70	 sp. 2,2 cm 4 kg n. pz. 1	30207 00 400	30207 00 402	30207 00 403	30207 00 405	30207 00 410
piano 80x80	 sp. 3,2 cm 7,5 kg n. pz. 1	30208 00 400	30208 00 402	30208 00 403	30208 00 405	30208 00 410

iceberg



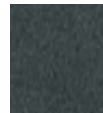

	werzalit alluminio				DurelTOP alluminio
					
9,7 kg	8 kg	10 kg	12,4 kg		10,5 kg

gambe iceberg 4

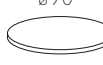

piani Ø60 - Ø70 - Ø80 - 60x60 - 70x70 - 80x80 werzalit - 80x80 durelTOP

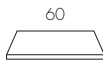
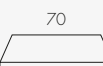
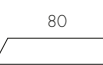
		
3 kg	anodizzato argento 52550.00.000	verniciato antracite 52552.00.000

piani werzalit

	senza agganci without hooks sans accrochements ohne Tragegriffe	sin enganches sem ganchos Werzalitabalar, çengelsiz без креплений	BIANCO	CATALAN	ARGENTO	WICKER *
piano Ø60		sp. 2,6 cm 4,3 kg n. pz. 1	1801430.00.190	1801430.00.194	1801430.00.197	1801430.00.198
piano Ø70		sp. 2,6 cm 5,5 kg n. pz. 1	1801630.00.190	1801630.00.194	1801630.00.197	1801630.00.198
piano Ø80		sp. 2,6 cm 6,7 kg n. pz. 1	1801930.00.190	1801930.00.194	1801930.00.197	1801930.00.198
piano 60x60		sp. 3 cm 5 kg n. pz. 1	1801530.00.190	1801530.00.194	1801530.00.197	1801530.00.198
piano 70x70		sp. 3 cm 7 kg n. pz. 1	1801730.00.190	1801730.00.194	1801730.00.197	1801730.00.198
piano 80x80		sp. 3,3 cm 9,4 kg n. pz. 1	1801830.00.190	1801830.00.194	1801830.00.197	1801830.00.198
piano 110x70		sp. 3 cm 11,4 kg n. pz. 1	1802130.00.190	1802130.00.194	1802130.00.197	
piano 120x80		sp. 3,3 cm 14,7 kg n. pz. 1	1802030.00.190	1802030.00.194	1802030.00.197	

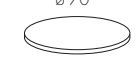
piani werzalit iceberg

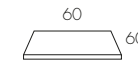
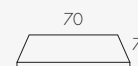
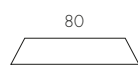
	con agganci with hooks avec accrochements mit Tragegriffe	con enganches sem ganchos werzalitabalar, çengelli с креплениями	BIANCO	CATALAN	ARGENTO	WICKER *
piano Ø60		sp. 2,6 cm 4,3 kg n. pz. 1	30116.10.190	30116.10.194	30116.10.197	30116.10.198
piano Ø70		sp. 2,6 cm 5,5 kg n. pz. 1	30117.10.190	30117.10.194	30117.10.197	30117.10.198
piano Ø80		sp. 2,6 cm 6,7 kg n. pz. 1	30118.10.190	30118.10.194	30118.10.197	30118.10.198
piano 60x60		sp. 3 cm 5 kg n. pz. 1	30106.10.190	30106.10.194	30106.10.197	30106.10.198
piano 70x70		sp. 3 cm 7 kg n. pz. 1	30107.10.190	30107.10.194	30107.10.197	30107.10.198
piano 80x80		sp. 3,3 cm 9,4 kg n. pz. 1	30108.10.190	30108.10.194	30108.10.197	30108.10.198

* Posizionare in zona d'ombra - Only use table tops in shaded areas - Plateaux qui doivent être utilisés uniquement dans des zones ombragées - Tischplatten nur für beschatteten Einsatzbereich - Utilizar estos tableros sólo en áreas sombreadas - Gölge alana koyun - Ставить в тени

* Posizionare in zona d'ombra - Only use table tops in shaded areas - Plateaux qui doivent être utilisés uniquement dans des zones ombragées - Tischplatten nur für beschatteten Einsatzbereich - Utilizar estos tableros sólo en áreas sombreadas - Gölge alana koyun - Ставить в тени

regina meeting

polipropilene
alluminio

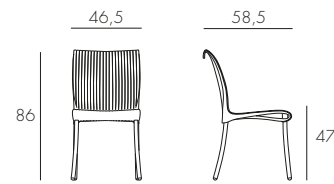

3,1 kg
n. pz. 18



ANTRACITE
anodizzato argento
61950.02.000

CAFFÈ
anodizzato argento
61950.05.000

ROSSO
anodizzato argento
61950.07.000

BURRO
anodizzato argento
61950.28.000

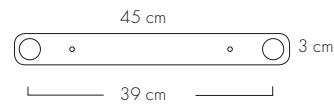

10 pz.+10 pz. kg 0,7

4 pz. kg 1,9

206180303

16618010

distanziale anteriore
spacer front
crochet avant
platzhalter vorne
enganche anterior
ganchos frente
ön ara parçası
передняя распорка

distanziale posteriore
spacer rear
crochet arrière
platzhalter hinten
enganche posterior
gancho para trás
arka ara parçası
задняя распорка

staffa a terra
bracket
barre d'assemblage au sol
bracket
soporte
suporte
üzengi
наземная скоба

Sedia ignifuga per la collettività con distanziali e staffa. Classe M3 (NF P 92 505: dicembre 1995) e classe 2 (UNI 9177).
Fireproof meeting chairs with spacers and brackets. Class M3 (NF P 92 505: december 1995) and class 2 (UNI 9177).
Chaise ignifugée pour la collectivité avec crochets et barre d'assemblage au sol. Classe M3 (NF P 92 505: décembre 1995) et classe 2 (UNI 9177).

Der feuerfeste Stuhl speziell für die Theaterbestuhlung mit Verbindungshalter seitlich und Abstandhalter gegen hinten. Klasse M3 (NF P 92 505: Dezember 1995) und Klasse 2 (UNI 9177).
Gruplar için bağlantı ve ara parçaları, ateşe dayanıklı sandalye. Sınıf M3 (NF P 92 505: Aralık 1995) and sınıf 2 (UNI 9177).
Silla ignifuga para uso colectivo con enganches y soporte. M3 de clase (NF P 92 505: diciembre de 1995) y clase 2 (UNI 9177).
Огнестойкий стул для коллектива с распорками и скобой. Класс М3 (NF P 92 505: ДЕКАБРЬ 1995) и класс 2 (UNI 9177).

Cadeira à prova de fogo para a colectividade com ganchos e suporte. Classe M3 (NF P 92 505: dezembro de 1995) e classe 2 (UNI 9177).
Gruplar için bağlantı ve ara parçaları, ateşe dayanıklı sandalye. Sınıf M3 (NF P 92 505: Aralık 1995) and sınıf 2 (UNI 9177).
Огнестойкий стул для коллектива с распорками и скобой. Класс М3 (NF P 92 505: ДЕКАБРЬ 1995) и класс 2 (UNI 9177).

distanziale bistrot

bora bistrot, riva bistrot, costa bistrot

polipropilene



202430402

distanziale anteriore
spacer front
crochet avant
platzhalter vorne
enganche anterior
ganchos frente
ön ara parçası
передняя распорка

distanziale posteriore
spacer rear
Crochet arrière
platzhalter hinten
Enganche posterior
gancho para trás
Arka ara parçası
задняя распорка

clean resin

detergente 0,5 l

n. pz. 12



39101.00.000

clean resin special

detergente 4 l

n. pz. 1



Detergente specifico per la pulizia dei lettini Alfa e Omega
Detergent specific for the cleaning of our sunloungers Alfa and Omega
Détergent spécifique pour nettoyer nos lits Alpha et Omega
Reinigungsmittel speziell geeignet für die Reinigung unseren Liegen Alpha und Omega
Detergente para la limpieza de nuestra camas Alfa y Omega
Detergente para a limpeza de nossas camas Alpha e Omega
Alfa ve Omega kumaşı için özel sıvı deterjan
Специальное моющее средство для лежаков alfa и omega



39102.00.000

cuscino eden

cm 185 (65+120) x 57 x 5



36414.01.160

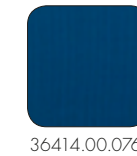

36414.00.076



Fibra Acrilica 100%. Trattamento con resina poliuretano/acrilica, IDROREPELENTE
100% acrylic fiber. Finish resin poliuretano/acrilic, water-repellent
100% fibre acrylique. Traitement avec une résine de polyuréthane/acrylique hydrofuge
100% fasergefärbtes Acryl. Sondergewebeausrüstung mit Polyurethan-Harz/Acryl wasserabweisend
100% fibra acrílica. Tratamiento con resina de poliuretano/acrílico repelente al agua
100% fibra acrílica. Tratamento com resina de poliuretano/acrílico à prova d'água
100% toprak boyalı Akrilik Elyaf. Kumaşa su geçirmezlik uygulaması yapılmıştır
100% акриловое волокно. Водоотталкивающая обработка полиуретановой/акриловой смолой

polipropilene

Polipropilene trattato anti-UV e colorato in massa. Riciclabile al 100%. Polypropylene with UV additives and is uniformly colored. 100% Recyclable resin. Polypropylène traité anti-UV et coloré dans la masse. Résine recyclable 100% UV-beständigem Polypropylen, voll durchgefärbt. 100% Recyclebarer Kunststoff. Polipropileno tratado anti UV y teñido en masa. Resina reciclable 100%. Polipropileno com tratamento anti-UV colorido na totalidade. Resina reciclável 100%. Işığa dayanıklı ve boyalı olarak granül çekilmiş %100 geri dönüşümlü polipropilen kompozit hammaddede.

Полипропилен с обработкой анти-УФ, окрашенное в массе. На 100% пригодно для вторичной переработки.



polipropilene fiberglass

Polipropilene fiberglass trattato anti-UV e colorato in massa. Resina riciclabile al 100%. Uniformly colored fiberglass polypropylene resins with uv additives. 100% Recyclable resin. Polypropylène fiberglass traité anti-uv et coloré dans la masse. Résine recyclable 100%. UV-beständigem fiberglass Polypropylen, voll durchgefärbt. 100% Recyclebarer Kunststoff. Polipropileno fiberglass tratado anti UV y teñido en masa. Resina reciclable 100%. Polipropileno fiberglass com tratamento anti-UV colorido na totalidade. Resina reciclável 100%. Işığa dayanıklı ve boyalı olarak granül çekilmiş %100 geri dönüşümlü cam elyaf katkılı polipropilen kompozit hammaddede.

Полипропилен фиброволокно с обработкой анти-УФ, окрашенное в массе. На 100% пригодно для вторичной переработки.

alluminio

anodizzato

L'anodizzazione è un processo elettrolitico che aumenta l'ossidazione delle superfici prevenendo la corrosione con uno strato protettivo. Anodizing is an electrolytic procedure that increases oxidation of the surfaces, preventing corrosion with a protective layer. L'anodisation est un procédé électrolytique qui augmente l'oxydation des surfaces empêchant ainsi la corrosion grâce à une couche de protection.

Die Eloxierung ist ein elektrolytischer Prozess, der die Oxydierung der Oberflächen erhöht und der Korrosion mit einer Schutzschicht vorbeugt. La anodización es un proceso electrolítico que aumenta el poder de oxidación de las superficies evitando de esta manera la corrosión mediante una capa protectora.

A anodização é um processo electrolítico que aumenta a oxidação

das superficies prevenindo a corrosão com uma camada protectora. Anodizing yüzeylerin oksillenmesini arttıran ve koruyucu bir tabakayla paslanmayı önleyen bir işlemdir. Анодирование представляет собой электролитный процесс, который повышает окисление поверхностей, предотвращая коррозию благодаря образованию защитного слоя.

verniciato

La verniciatura è a polvere di poliestere. The painting is with polyester powder. La peinture est à poudre de polyester. Die Epoxierung erfolgt mit Polyesterpulver. El pintado se realiza con

polvo de poliéster. O pó de poliéster é usado para envernizar. Boyası polyester tozla yapılır. Окраска производится при помощи порошкового полиэстера.



acciaio cromato

Acciaio con trattamento galvanico superficiale per prevenire la corrosione. Chromed steel galvanized to prevent corrosion. Acier avec traitement galvanique superficiel pour prévenir la cor-

rosion. Verchromter Edelstahl, verzinkt, um Rost vorzubeugen. Aço com tratamento galvanizado superficial para prevenir a corrosión. Aço galvanizado para prevenir corrosão.

Korozyona karşı galvanizlenmiş paslanmaz çelik. Сталь с поверхностной гальванической обработкой, предотвращающей коррозию.



acciaio cromato .80

DurelTOP

DurelTOP è un sistema innovativo di produzione di piani per tavoli studiati per raggiungere i più elevati livelli di praticità, resistenza, robustezza ed eleganza. I piani DurelTOP sono ad alto spessore, formati da un doppio strato tamburato perfettamente chiuso. Prodotti in polipropilene di prima qualità, sono inalterabili all'acqua, resistenti al sole e facili da pulire. DurelTOP è il risultato di una lunga ricerca tecnologica e dell'esperienza decennale nella lavorazione delle materie plastiche della Nardi, da sempre all'avanguardia nell'ambiente contract e giardino.

The DurelTOP is an innovative new system in the production of tabletops developed to reach the highest levels of practicality, resistance, and elegance. The DurelTOP tabletops have a greater thickness, formed by a double layer enclosure perfectly closed. Produced in first quality polypropylene, they are resistant to water, resistant to sunlight, and are easy to clean. DurelTOP is a result of a decade's long research and development in plastics by Nardi, always a leader in the contract and garden sectors.

DurelTOP est un système innovateur de production de plateaux de tables, il est étudié pour retrouver le meilleur niveau de pratique de résistance et d'élegance. Les plateaux DurelTOP sont très épais, formés de doubles couches parfaitement finies. Ce sont des produits en polypropylène de première qualité, ils sont inaltérables à l'eau, résistants au soleil et faciles à nettoyer. DurelTOP est le résultat d'une longue recherche technologique et une expérience décennale

dans le travail des matières plastique de la Sté Nardi, toujours à l'avant-garde dans le secteur du contract et jardin.

DurelTOP ist ein neu entwickeltes System für die Produktion von Tischplatten, um ein Höchstmaß an Funktionalität, Widerstandsfähigkeit und Eleganz zu erreichen. Durch das innen verstärkte "Zwei-Schichten-Hohlraum-System" erreicht die DurelTOP Tischplatte einen stärkeren Querschnitt und damit ein Höchstmaß an Festigkeit. Hergestellt aus hochwertigem Qualitätspolypropylen ist sie resistent gegen Wasser und Sonnenlicht und dabei leicht zu reinigen. DurelTOP ist das Ergebnis von 10 Jahren Forschung und Entwicklung auf dem Kunststoffsektor durch Nardi, immer der führende im Bereich Contract- und Gartenmöbel.

DurelTOP es un nuevo sistema de fabricación de tableros de mesa estudiado para alcanzar los mas altos niveles de practicidad, resistencia, robustez y elegancia. Los tableros DurelTOP de gran solidez, estan formados por una doble capa perfectamente unida y sellada. Fabricados en polipropileno de primera calidad son inalterables al agua, resistentes al sol y de fácil limpieza. DurelTOP es el resultado de una prolongada investigación tecnológica y de la experiencia acumulada en los mas de diez años que Nardi lleva produciendo materias plasticas, siempre innovando en ambientes contract y jardin.

DurelTOP é um sistema de inovação da produção de tampos de

mesa concebidos para atingir a máxima resistência,práticos e elegantes. Os tampos de mesa DurelTOP são formados poruma camada dupla e perfeitamente unida. Produzidos em polipropileno de primeira qualidade, são resistentes ao sol e fáceis de limpar. DurelTOP é o resultado de uma longa investigação tecnológica em materiais plásticos da Nardi, leader em mobiliário de jardim.

DurelTOP, masa tablalarrın üretiminde kullanılan yeni bir sistem olup, yüksek seviyede pratiklik, direnç ve de sıklık sunmak amacıyla geliştirilmiştir. DurelTOP masa tablaları fevkalade bir inceliğe sahip olup, kusursuz kapanan çift tabaka çevirme sistemiyle oluşturulmuştur. Nitelikli çamsakızından üretilmiş olup, suya ve güneş ışığına karşı dirençli ve temizlenmesi kolaydır. DurelTOP sistemini Contract ve de Bahçe sektöründe her zaman lider olan Nardi'nin uzun araştırmalarının sonucundan doğan, plastikte gelişim olarak adlandırabiliriz.

DurelTOP — это инновационная система производства столешниц, позволяющая изготавливать практичные, прочные, крепкие и элегантные столешницы. Столешницы DurelTOP обладают высокой плотностью и состоят из двойной панели с мелкопустотным заполнением, полностью закрытой. Изделия из полипропилен высокого качества устойчивы к воде, солнцу и просты в уходе. DurelTOP — это результат многолетних технологических исследований и десятилетнего опыта Nardi в обработке пластмасс, лидера в производстве садовой мебели и контрактном секторе.



laminato HPL

Laminato decorativo ad alta pressione, compatto, omogeneo, non poroso, ad alta densità.
Decorative high pressure laminate, solid, homogeneous, non-porous and with a high density.
Stratifié décoratif à haute pression, condensé, homogène, pas poreux, haute densité.

HPL-Laminat, beständig, homogen, hoch verdichtet.
Laminado decorado a alta presión, compacto, homogéneo, no poroso y de alta densidad.
Decorativo e laminado a alta pressão, sólido, homogéneo, não poroso e de grande densidade.

Dekoratif yüksek basınçlı laminat, masif, gözeneksiz ve yüksek yoğunluklu.
Декоративный ламинат высокого давления, компактный, однородный, непористый, с высокой плотностью.

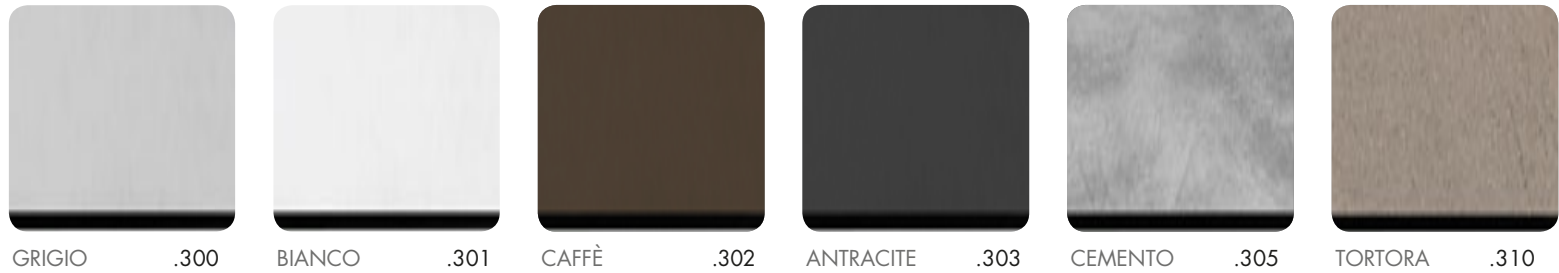

werzalit

Piano speciale protetto da laminato melaminico decorato, di facile pulizia, resistente alle macchie, al calore, alle intemperie.
Werzalit tops are protected by a special printed foil that is weather proof, easy to clean and resistant to marks and heat.
Plateau special protégé en laminé décoré, facile à nettoyer, résistant aux taches, à la chaleur et aux intempéries.

Spezialplatte, mit verzierten Melaminlaminat geschützt leicht zu reinigen, widerstandsfähig gegen Flecken, gegen Wärme und Witterungseinflüsse.
Tablero de mesa especial protegido por una lamina melaminica decorada, de fácil limpieza, resistente a las manchas, el calor y la intemperie.

Os tamos werzalit estão protegidos com uma película especial à prova de água, fácil de limpar, resistente as manchas e ao calor.
Werzalit tablolar dışetkenlere karşı dayanıklı olan, temizliği kolay ve çizilmeye ve ısıya karşı dayanıklı özel bir tabakayla korunur.
Особая столешница, защищенная декорированным меламиновым ламинатом, который устойчив к пятнам, теплу и негативному воздействию окружающей среды.



vetro

Vetro float temperato serigrafato e vetrificato a 700°C.
Tempered Float glass, screen-printed and vitrified at 700°C.
Verre float trempé sérigraphié et vitrifié à 700°C.

Sicherheitsglas mit innenliegendem Dekorsiebdruck, verglast bei 700°C.
Vidrio float, templado, serigrafado y vetrificado a 700°C.

Vidro float temperado, impresso e vitrificado a 700°C.
Temperli, üstü baskılı ve 700°C vitrifiye edilmiş.
Сериграфированное закаленное стекло float, производимое при 700°C.



tessuto acrilico

cuscino aria poltrona

Fibra Acrilica 100% tinta in massa. Solidità alla luce 7/8. Sfoderabile/zip, lavabile a 30°C. CUSCINO SEDUTA = imbottitura: poliuretano espanso. Densità 25 kg/m³. CUSCINO ARREDO = imbottitura: poliuretano espanso. Densità 25 kg/m³ rivestito da fibra 100% poliestere. Trattamento antimacchia, antimuffa.

100% acrylic fiber mass dyed. Light fastness 7/8. Removeable/zip, washable at 30°C. CUSCINO SEDUTA = padding: polyurethane foam. Density 25 kg/m³. CUSCINO ARREDO = padding: polyurethane foam. Density 25 kg/m³ with polyester fiber 100%. Stain-proof, mould-proof.

100% fibre acrylique teintée en masse. Solidité à la lumière 7/8. Déhoussable/zip, lavable à 30°C. CUSCINO SEDUTA = rembourrage: mousse polyuréthane. Densité 25 kg/m³. CUSCINO ARREDO = rembourrage: mousse polyuréthane. Densité 25 kg/m³ avec fibres de polyester 100%. Traitement anti-taches, anti-moisissure.

100% fasergefärbtes Acryl. Lichtbeständigkeit 7/8. Abziehbarer/zip, waschbar bei 30°C. CUSCINO SEDUTA = polsterung: polyurethanschäum. Dichte 25 kg/m³. CUSCINO ARREDO = polsterung: polyurethanschäum. Dichte 25 kg/m³ beschichtet Polyesterfasern 100%. Mit Anti-Flecken- und Anti-Schimmel-Behandlung.

100% fibra acrílica tintada en masa. Solidez a la luz 7/8. Desfundable/zip, lavable a 30°C. CUSCINO SEDUTA = relleno: espuma de poliuretano. Densidad 25 kg/m³. CUSCINO ARREDO = relleno: espuma de poliuretano. Densidad 25 kg/m³ cubierta con fibras de poliéster 100%. Tratamiento antimanchas, antimoho.

100% fibra acrílica tingida em massa. Resistência à luz 7/8. Removível/zip, lavável a 30°C. CUSCINO SEDUTA = acolchoamento: espuma de poliuretano. Densidade 25 kg/m³. CUSCINO ARREDO = acolchoamento: espuma de poliuretano.

Densidade 25 kg/m³ com cobertura fibras de poliéster 100%. Tratamento antimancha, antimoho.

%100 toprak boyalı Akrilik Elyaf. Işığa dayanıklılık 7/8. Çıkarılabilir kılıf/fermuar, 30°C'de yıkanabilir. MINDER = içi: köpük poliüretan. Yoğunluk 25 kg/m³. KIRLENT = içi: köpük poliüretan. Yoğunluk 25 kg/m³, %100 polyester elyaf kaplı. Kir tutmaz, küf önleyici.

100% акриловое волокно, окрашенное в процессе производства. Светостойкость 7/8. Съемная ткань/на молнии, стирка при 30°C. ПОДУШКА СИДЕНИЯ = наполнитель: пенополиуретан. Плотность 25 кг/м³. ПОДУШКА ДЕКОРАТИВНАЯ = наполнитель: пенополиуретан. Плотность 25 кг/м³, обивка из 100% полиэстера. Обработка против пятен, противогрибковая.



tessuto acrilico

cuscino eden

Fibra Acrilica 100%. Solidità alla luce 7/8. Sfoderabile/zip, lavabile a 30°C. imbottitura: poliuretano espanso. Densità 18 kg/m³. Trattamento con resina poliuretano/acrilica, idrorepellente.

100% acrylic fiber. Light fastness 7/8. Removeable/zip, wash at 30°C. Padding: polyurethane foam. Density 18 kg/m³. Finish resin poliuretano/acrilic, water-repellent

100% fibre acrylique. Solidité à la lumière 7/8. Déhoussable/zip, lavable à 30°C. Rembourrage: mousse polyuréthane. Densité 18 kg/m³. Traitement avec une résine de polyuréthane/acrylique hydrofuge.

100% fasergefärbtes Acryl. Lichtbeständigkeit 7/8. Abziehbarer/zip, Bei 30°C waschbar. Polsterung: polyurethanschäum. Dichte 18 kg/m³. Sondergewebeausrüstung mit Polyurethan-Harz/Acryl wasserabweisend

100% fibra acrílica. Solidez a la luz 7/8. Desfundable/zip, lavable a 30°C. Relleno: espuma de poliuretano. Densidad 18 kg/m³. Tratamiento con resina de poliuretano/acrílico repelente al agua.

100% fibra acrílica. Resistência à luz 7/8. Removível/zip, lavável a 30°C. Acolchoamento: espuma de poliuretano. Densidade 18 kg/m³.

de 18 kg/m³. Tratamento com resina de poliuretano/acrílico à prova d'água.

100% toprak boyalı Akrilik Elyaf. Işığa dayanıklılık 7/8. Çıkarılabilir kılıf/fermuar, 30°C'de yıkanabilir. İç: köpük poliüretan. Yoğunluk 18 kg/m³. Kumaşa su geçirmezlik uygulaması yapılmıştır.

100% акриловое волокно. Светостойкость 7/8. Съемная ткань/на молнии, стирка при 30°C. Наполнитель: пенополиуретан. Плотность 18 кг/м³. Водоотталкивающая обработка полиуретановой/акриловой смолой.

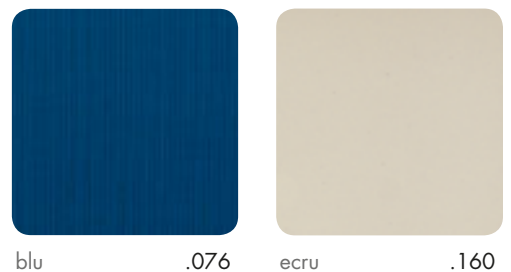

tessuto sintetico

Tessuto in filo di poliestere rivestito in pvc.
Fabric is made of a polyester fiber, with a pvc coating.
Tissu en fil de polyester revêtu de pvc.

Gewebe aus PVC-ummantelten Polyesterfasern.
Tejido en hilo de poliéster recubierto de pvc.
Tecido de fibra polyester com cobertura pvc.

PVC kaplı polyester elyaf tekstil.
Ткань из полиэфирных нитей с покрытием из ПВХ.

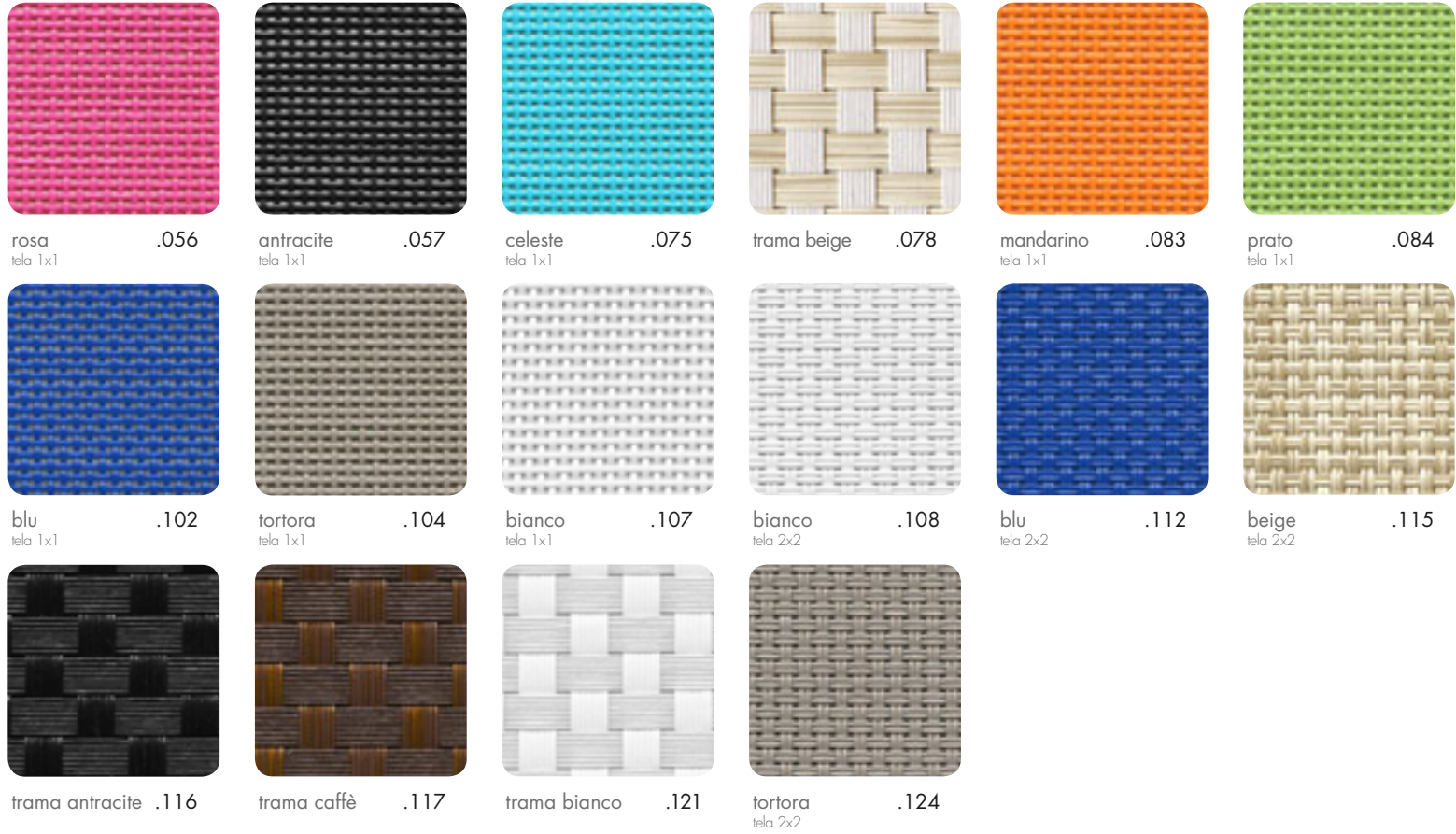

 impilabile stackable empilable stapelbar apilable empilhável kaymaz ayaklı стекируемые

 impilabile orizzontalmente stackable horizontally piètement encastrable horizontal stapelbar apilable horizontalmente empilhável horizontalmente yatay olarak istiflenebilir горизонтальная расстановка

Tutte le sedute sono dotate di piedini antiscivolo. All chairs are equipped with non-slip rubber feet. Tous les sièges sont équipés avec embouts anti-dérapants. Alle Stühle sind mit rutschfesten Fußkappen ausgestattet. Todos los asientos están equipados con tacos antideslizantes. Todos os assentos estão equipados com pés anti-derrapantes. Bütün sandalyeler kaymaz ayaklıdır. Ножки всех стульев оснащены противоскользящей резиновой подложкой.

Sui colori scuri, ombre ed altri difetti minori sono più evidenti rispetto ai colori chiari e sono da ritenersi standard. On dark colors, shadows and other minor faults are more evident than on lighter colors and are therefore standard. Sur les couleurs sombres, les ombres et les autres petits défauts sont plus marqués que sur les couleurs claires et sont tout à fait standards. Auf dunklen Farben sind Schatten und andere kleinere Mängel sichtbarer als auf hellen Farben und sind daher als Standard zu betrachten. Las sombras y demás defectos menores son más evidentes sobre los colores oscuros respecto a los colores claros y tienen que considerarse como estándares. Em cores escuras, sombras e outros defeitos menores são mais evidentes do que em cores claras e devem ser considerados standard. Koyu renkler üzerinde, gölgeler ve diğer küçük defolar açık renklerin üzerinde olduklarından daha belirginleşmekte ve bu nedenle normal olarak değerlendirilmelidir. По сравнению со светлыми цветами на темных цветах тени и другие небольшие дефекты более заметны и должны считаться нормой.

Il peso (kg), le misure (cm) e i colori riportati sono indicativi. La NARDI si riserva il diritto di apportare modifiche o varianti senza preavviso. Tutti i modelli sono depositati. Weights (kg), dimensions (cm) and colors are indicative only. NARDI reserves the right to make changes or variations without notice. All models are patented. Le poids (kg), les dimensions (cm) et les coloris indiqués sont fournis purement à titre indicatif. La Firma NARDI se réserve le droit d'apporter toute modification ou variation sans aucun préavis. Tous les modèles sont déposés. Alle Farb-, Maß- (cm) und Gewichtsangaben (kg) sind nicht als fest bindend anzusehen. Firma NARDI behält sich das Recht von Änderungen. Alle Modelle sind gesetzlich geschützt. El peso (kg), las medidas (cm) y los colores detallados, son indicativos. La firma NARDI se reserva el derecho de modificaciones o variaciones sin previo aviso. Todos los modelos llevan nuestra marca. O peso (kg), as medidas (cm) e as cores indicadas, são indicativas. A NARDI reservase o direito de aportar modificações ou variações sem préaviso. Todos os modelos estão depositados. Ağırlık (kg), boyutlar (cm) ve renkler gösterme amaçlıdır. NARDI'nin önceden bildirmeden değişiklik yapma hakkı vardır. Bütün modeller patentlidir. Приведенный вес (кг), размеры (см) и цвета являются ориентировочными. Компания NARDI оставляет за собой права вносить изменения и вариации без предварительного предупреждения. Все модели зарегистрированы.



YOUR OUTDOOR LIVING

NARDI s.p.a.
Chiampo (VI) Italy
tel. +39 0444 422100
www.nardigarden.com



2016

